



**THE LEICA -
TYPE SHUTTER**



NATIONAL CAMERA, INC.
Technical Training Division
(National Camera Repair School)

**Englewood,
Colorado
80110
U.S.A.**

Litho in U.S.A.

**PHOTO
EQUIPMENT
TECHNICIAN
COURSE**

**THE LEICA -
TYPE SHUTTER**

by

S. L. Love

revised by

S. L. Love

C. H. Schmitt

E. C. Fowler

Larry Lyells

National Camera
Technical Training Division
Englewood, Colo., U.S.A. 80110



THE LEICA -TYPE SHUTTER

But the closing curtain can't as yet enter the picture area — we need a slit to expose the film. Locate the **closing-curtain latch** in Fig. 53. Before the closing curtain enters the aperture, the closing-curtain latch catches a tab on the closing-curtain wind gear. The closing-curtain wind gear remains held until we disengage the closing-curtain latch.

As with the drum-type design, the opening curtain releases the closing curtain. The actual part that performs the disengaging action in Fig. 53 is the **speed knob** (the knob you turn to set the shutter speed). There's a downward-projecting pin on the underside of the speed knob — this pin fits into one of the holes in the speed-control gear. So the speed knob always turns with the opening-curtain winding roller.

You select the shutter speed just as you do with the Leica design discussed previously — lift the speed knob, turn it to the desired setting, and allow it to drop into the proper hole in the speed-control gear. You've then fixed the distance between the speed-knob pin and the closing-curtain latch.

The speed-control gear now rotates as the opening curtain moves across the picture area. And, at the proper time during the opening-curtain travel, the speed-knob pin strikes the closing-curtain latch; that frees the closing curtain. So the closing curtain follows the opening curtain at the right distance for the selected slit width.

The timing between the gears is critical in determining the slit width. If you disturb the gear timing during disassembly, you'll throw off the slit width and the curtain overlap. So it's a good idea to scribe gear timing before disassembly — that often eliminates the time-consuming process of adjusting the gearing to correct the shutter speed and the overlap.

For example, consider that you've just serviced the shutter of Fig. 53. And, in the process, you've disturbed the gear timing. When checking the shutter speeds after reassembly, you find the fastest speed is too slow. Assuming that the camera's clean and in good operating condition, it's possible to correct the fastest speed by increasing the curtain overlap — the more the curtains overlap during the wind cycle, the smaller the slit will be on the release cycle.

In most double-roller designs, your curtain adjustments involve retiming the gears. So you'll change the timing between the closing-curtain wind gear and the closing-curtain-winding-roller pinion to set the position of the closing curtain. And you'll adjust the timing between the opening-curtain wind gear and the opening-curtain-winding-roller pinion to set the overlap. That's one advantage the double-roller design has over the drum-type design — it's not so easy to adjust curtain timing in the drum-type shutter. Here, the positions at which the curtains are cemented on the drums determine the overlap and the position of the closing curtain.

Your next lesson takes a close look at a typical double-roller design. And it describes the procedures for setting the curtain timing.

46

CONTENTS

THE LEICA -TYPE SHUTTER

THE SELF-CAPPING FOCAL-PLANE SHUTTER	1
FLASH SYNCHRONIZATION WITH A FOCAL-PLANE SHUTTER	5
THE LEICA-TYPE SHUTTER — MOST COMMON SELF-CAPPING DESIGN	5
BASIC OPERATION OF THE LEICA-TYPE SHUTTER	8
MAKING NEW CURTAINS	9
CURTAIN POSITIONS IN THE CAMERA	10
THE TAKE-UP ROLLERS	12
THE CURTAIN DRUM	17
THE CURTAIN-WINDING MECHANISM	22
THE SPEED-CONTROL MECHANISM	26
THE LEICA SLOW-SPEED SYSTEM	38
COUPLING THE SLOW-SPEED MECHANISM TO THE CURTAINS	41
VARIATIONS IN THE DESIGN OF THE LEICA-TYPE SHUTTER	44

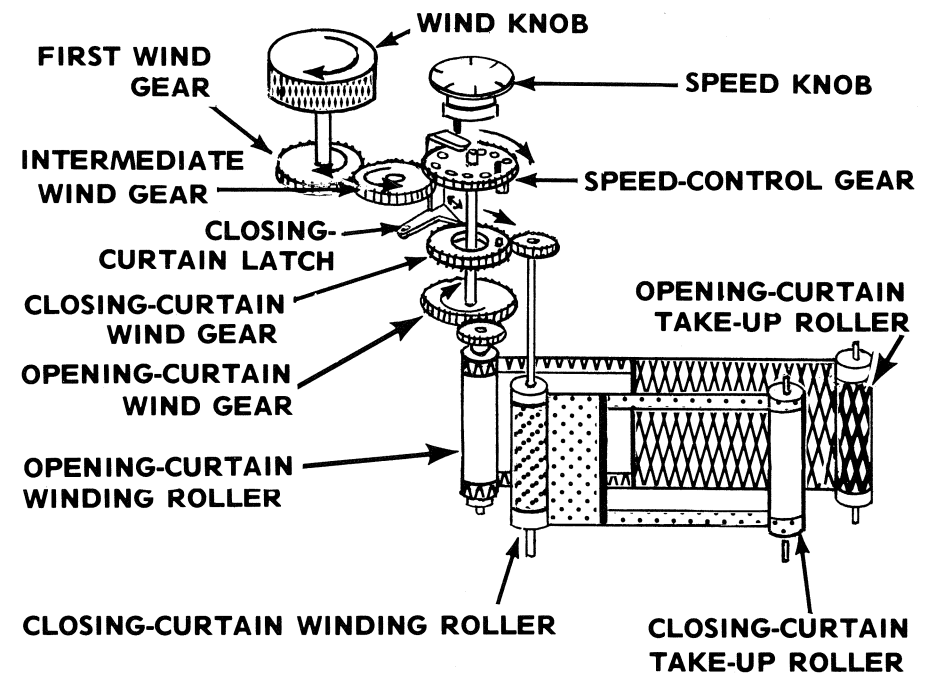

ARROWS INDICATE DIRECTION OF ROTATION ON WINDING CYCLE

FIGURE 53

Consider in Fig. 53 that the intermediate wind gear can move vertically. There's a link between the intermediate wind gear and the camera's release button. Consequently, when you push the release button, the intermediate wind gear moves down — clear of the first wind gear. Such a transport-release mechanism is common in double-roller designs.

As soon as the intermediadiate wind gear clears the first wind gear, there's nothing holding the curtains. Now, the speed-control gear rotates as the opening curtain crosses the picture area.

The initial rotation of the speed-control gear frees the closing-curtain wind gear — the downward-projecting stud of the speed-control gear no longer engages the stud on the closing-curtain wind gear. So the closing curtain is free to follow the opening curtain across the picture area.

THE LEICA - TYPE SHUTTER

models of the Leica, the pallet in the escapement isn't adjustable. It remains engaged with the star wheel at all of the slow speeds. Then, there may be a one-way clutch built into the first-gear segment that allows the retard levers to return quickly to the "ready" position.

Later screw-mount Leica models use the adjustable pallet. So there are two slow-speed ranges. On the speeds of 1/20 second through 1/10 second, the pallet is disengaged. The pallet moves into engagement at the three slowest speeds — 1/4 second (or 1/5 second), 1/2 second, and 1 second. The pallet disengages after every exposure to allow the retard levers easy return to the "ready" position.

In models with an adjustable pallet, the slow-speed cam controls two shutter parts. The front surface of the slow-speed cam operates the retard rod as previously described. In addition, a cam follower rides against the side of the slow-speed cam. The other end of the cam follower engages the pallet lever in the escapement. So the slow-speed cam controls the pallet engagement as well as the depth of retard-lever engagement. You'll see this design during your study of the actual camera disassembly in **NatCam Manual # 327**.

Variations in the Design of the Leica-Type Shutter

Once you understand the operation of the Leica, you'll have little difficulty spotting variations in different cameras using the Leica-type shutter. But there's one variation you'll encounter frequently. So it deserves a mention at this time.

Rather than the curtain drum, many self-capping focal-plane shutters use two separate winding rollers. Each curtain has its own winding roller.

In the double-roller design, the opening curtain still winds and releases the closing curtain. Fig. 53 shows a typical arrangement. Notice that the opening curtain gears directly to the wind knob. As you turn the wind knob in the direction of the curved arrow, an idler gear rotates the **speed-control gear**.

A shaft connects the speed-control gear to the **opening-curtain wind gear**. And the opening-curtain wind gear engages a pinion on top of the opening-curtain winding roller. So turning the wind knob pulls the opening curtain to the "ready" position.

The speed-control gear in Fig. 53 also advances the closing curtain. Locate the downward-projecting stud on the underside of the speed-control gear — this stud interlocks with a stud on top of the **closing-curtain wind gear**. And the closing-curtain wind gear engages a pinion on top of the closing-curtain winding roller.

So during the cocking cycle, both curtains move together to the "ready" position. Releasing the shutter now requires some type of transport-release mechanism — we must somehow disengage the gear train from the curtains, allowing the curtains to move in the release direction.

THE LEICA - TYPE SHUTTER

The Self-Capping Focal-Plane Shutter

You've seen that the multiple-slit focal-plane shutter offers several advantages — high efficiency, convenient lens interchangeability, and often faster speeds than might be obtained from a leaf-type shutter. Still, it's a drawback when you have to protect the film from light whenever you wind the shutter or select a shutter speed. And the fixed curtain openings limit the slow-speed range.

But it's possible to eliminate these disadvantages by adding a second curtain at the focal plane. Two separate curtains working together to make the exposure — that's the basis of the self-capping focal-plane shutter.

The curtains of a self-capping focal-plane shutter still wind across the picture area in one direction — and then fire across in the opposite direction to make the exposure. But during the wind cycle, one curtain overlaps — caps — the other, Fig. 1. And that protects the film.

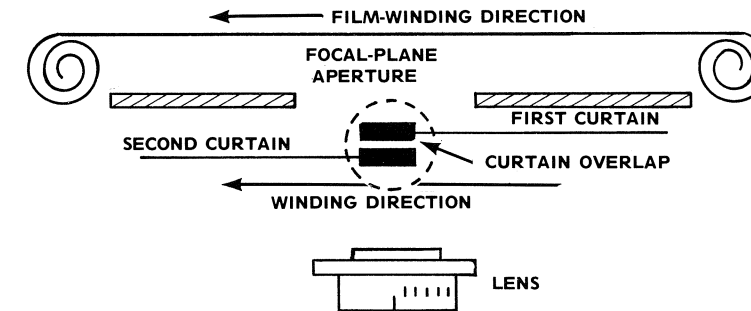

FIGURE 1 THESE ILLUSTRATIONS ARE DRAWN OUT OF PROPORTION FOR CLARITY.

Each curtain operates independently; each has its own rollers and its own return spring. Although the two curtains travel in unison to the "ready" position, they're released separately. Pushing the release button frees the first curtain. The other follows at a distance determined by the shutter-speed setting.

Differing from the Speed Graphic, there's only one curtain speed. The speed is fixed — you can't change it. But you still change

THE LEICA - TYPE SHUTTER

the slit width to get the right exposure. Rather than a series of fixed openings cut in the material, the slit is formed between the two curtains during the release cycle.

So the slit width (the distance between the two curtains) can be any size within the limits of the focal-plane aperture. All that's necessary is to change the time of release for the second curtain.

Selecting the shutter speed predetermines the spacing between the two curtains on the release cycle. An entire slow-speed range is possible by holding the aperture open for any length of time. Since the two curtains operate independently, one can be held back after the first has completely crossed the picture area.

In miniature (35mm) cameras using self-capping focal-plane shutters, the curtains usually travel horizontally across the aperture — first in one direction during the wind stroke, and then in the opposite direction during the exposure cycle. With larger formats, such as 120, the curtain movement is often vertical. But for explanation purposes, let's assume that you're looking at a miniature camera from the front of the focal-plane aperture. Here, the curtains normally move from right to left during the winding cycle and from left to right during the release cycle.

In Fig. 2, both curtains are traveling together to the "ready" position. So they're both adding tension to their own return springs. At the same time, the camera advances the film to the next frame.

Notice that the two curtains overlap during the winding cycle — that protects the film. With the shutter fully cocked, one curtain completely clears the focal-plane aperture. But the film is still protected by the second curtain which covers the entire frame, Fig. 3. The curtain now covering the aperture, Fig. 3, will be the first to cross the focal plane in the opposite direction when you release the shutter. So this curtain is the **opening curtain** — the curtain which "opens" the aperture to start the exposure.

When you release the shutter, the opening curtain starts moving from left to right, Fig. 4. Remember, the opening curtain always travels at the same speed. So exposure control has to come from the second curtain — the **closing curtain**.

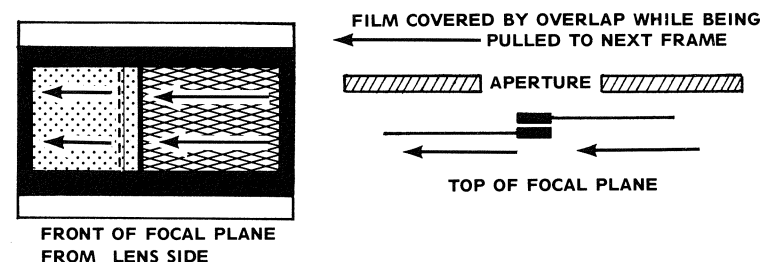

FIGURE 2 DURING WIND STROKE

Normally, the retard lever rests in its "down" position — it's pushed down by the upper-retard-lever spring. Here, the upper retard lever sits below the plane of the closing-curtain cam. If you cock the shutter when you're set at a slow speed, the closing-curtain cam rotates without interference — it just passes over the top of the upper retard lever.

But the instant the opening curtain crosses the aperture on the release cycle — just before tripping the closing-curtain latch — the retard rod jumps up. Now, the upper retard lever is in position to intercept the closing-curtain cam.

The part that controls the vertical movement of the retard rod is the **flat retard-rod spring** at the bottom of the camera, Fig. 51. The lower end of the retard rod sits on top of the flat retard-rod spring. Although it's not evident in the illustration, the flat retard-rod spring bends downward — toward the bottom of the camera. So the flat retard-rod spring allows the retard rod to move down. And that drops the upper retard lever below the plane of the closing-curtain cam.

Just before the opening curtain trips the closing curtain, the flat retard-rod spring moves up — toward the top of the camera. And that raises the upper retard lever to the level of the closing-curtain cam. The part that drives the flat retard-rod spring toward the top of the camera is the **opening-curtain cam**, Fig. 51.

The opening-curtain cam attaches to the opening-curtain-drum shaft. Once the opening curtain crosses the picture area, a pin on the opening-curtain cam strikes the flat retard-rod spring. The pin then drives the flat retard-rod spring toward the top of the camera — before the opening curtain has moved far enough to release the closing curtain.

When you wind the curtains for the next exposure, the pin on the opening-curtain cam moves away from the flat retard-rod spring. Then, the flat retard-rod spring bows downward. And the upper retard lever moves below the plane of the closing-curtain cam.

Let's summarize. Say you've set the slow-speed knob to a long exposure. As you wind the shutter, the closing-curtain cam rotates to its "ready" position; turning in this direction, the closing-curtain cam passes over the top of the upper retard lever.

Pressing down the release plunger frees the opening curtain. As the opening curtain nears the end of the focal plane, the pin on the opening-curtain cam strikes the flat retard-rod spring — that drives the retard rod toward the top of the camera, bringing the upper retard lever level with the closing-curtain cam.

Then, the disengaging lever kicks the closing-curtain latch to free the closing curtain. The closing curtain starts its travel, but it's stopped short of the aperture when the upper retard lever intercepts the closing-curtain cam. Now, the closing-curtain cam must swing the upper retard lever against the slow-down effect of the escapement. When the closing-curtain cam gets by the upper retard lever, the closing curtain completes its travel to end the exposure.

A spring on the first-gear segment of the escapement then returns the retard levers to the "ready" position — ready, that is, to delay the closing-curtain cam on the next release cycle. In earlier

THE LEICA-TYPE SHUTTER

At the "time" setting, the slow-speed cam pushes in the retard rod as far as it can. Here, the upper retard lever strikes a blocking screw (or a blocking plate, depending on the model). As a result, the closing-curtain cam can't push the upper retard lever aside. And the shutter stays open until you either turn the slow-speed knob to another setting or rewind the opening curtain to the "ready" position.

You've seen that the upper retard lever can move in two directions — in or out as you turn the slow-speed knob to set the depth of engagement, and from left to right when it's pushed aside by the closing-curtain cam, Fig. 52. The retard rod can also move in two directions. Besides its in-or-out movement, following the slow-speed cam, it can move up and down.

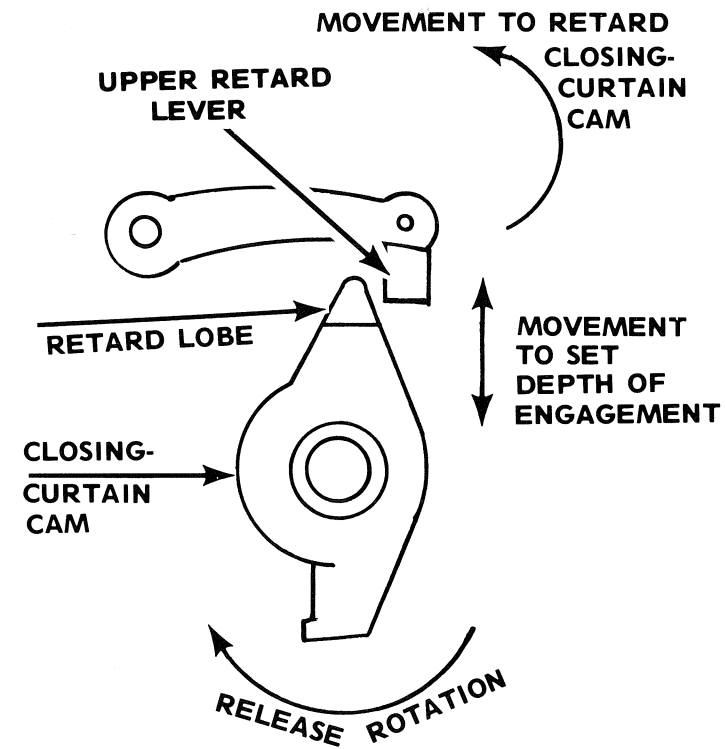

FIGURE 52

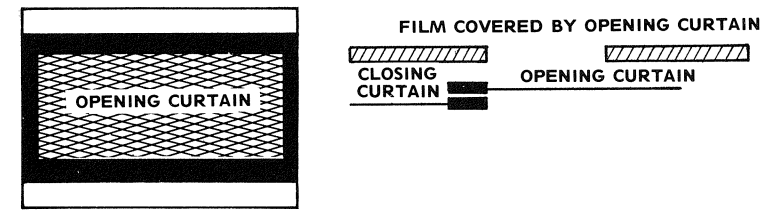

FIGURE 3 SHUTTER COCKED

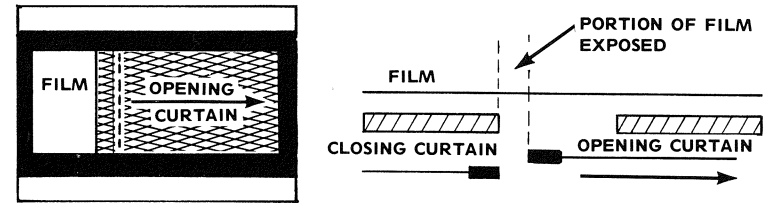

FIGURE 4 OPENING CURTAIN RELEASED

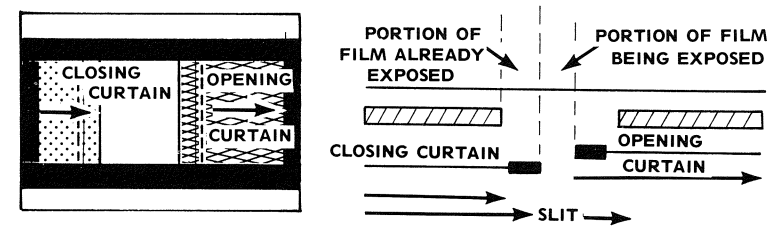

FIGURE 5 CLOSING CURTAIN FREED

Releasing first the opening curtain causes a time lag between the two curtains. And the result is a slit which moves across the aperture to make the exposure. In Fig. 4, the opening curtain partially clears the aperture and uncovers a section of film. But the shutter controls hold back the closing curtain — how long depends on the shutter-speed setting.

In effect, setting a shutter speed selects a certain point in the opening curtain's travel to free the closing curtain. When the opening curtain reaches this point, it disengages the closing curtain. Now, the closing curtain follows in the same direction. And the slit formed between the two curtains moves across the focal-plane aperture to expose the film, Fig. 5.

THE LEICA-TYPE SHUTTER

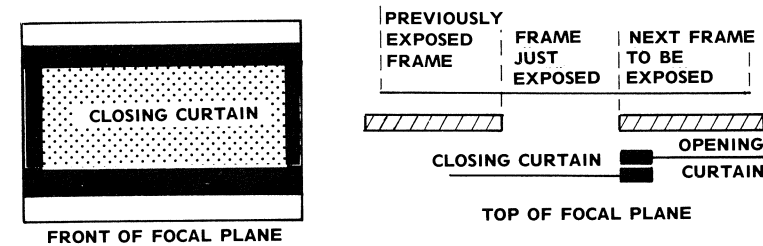

FIGURE 6 SHUTTER RELEASED

The curtains then reach the right-hand side of the aperture and come to a stop. Now, the closing curtain covers the aperture to protect the film, Fig. 6. Winding the film for the next exposure starts the sequence again — the film moves to the next frame while the overlapped curtains travel from right to left.

Like the opening curtain, the closing curtain travels at a fixed speed. But you can change the release point of the closing curtain — and that varies the slit width, the distance between the two curtains. At a slow speed, the opening curtain completely crosses the aperture and exposes the entire film frame. The closing curtain remains latched for the duration of the exposure. So rather than moving a slit across the film, the shutter simply opens and closes.

Quite often a conventional escapement mechanism — nearly identical to the ones you studied in leaf-type shutters — holds the closing curtain. The escapement times the release. So by setting the escapement, you can get an entire range of slow speeds. The slowest speed is usually 1 second using a conventional escapement.

The intermediate and fast speeds don't use the escapement. Instead, as you've just seen, the shutter releases the closing curtain while the opening curtain is still partially covering the aperture. Speeds from 1/20 second through 1/2000 second may result by changing the release point of the closing curtain. The actual speed range depends on the particular camera.

Say that the opening curtain has just started its travel, Fig. 4. The sooner the closing curtain now releases, the narrower the slit and the faster the resulting shutter speed. On a very fast speed, like 1/1000 second, the opening curtain barely starts to move when the closing curtain begins to follow. And the distance between the curtains is a hairline slit which results in a fast shutter speed.

You can see that the independent curtain operation makes the slit completely flexible. The only limitations result from the mechanical controls which you will soon study. Rather than the Speed Graphic's "variable-tension, multiple-slit, single-curtain" design, we now have a "self-capping, variable-slit, constant-speed" focal-plane shutter.

Coupling the Slow-Speed Mechanism to the Curtains

The slow-speed system always controls the closing curtain — it never touches the opening curtain. So all we have to do is link the escapement to the closing-curtain cam. A retard lever, Fig. 50, intercepts a second lobe on the closing-curtain cam **after** the opening curtain has disengaged the closing curtain.

To enter the aperture, the closing curtain must first push aside the retard lever. And that's not easy — it has to push the retard lever against the opposition offered by the escapement. Does this sound familiar? It should. It's the same principle used to hold open the blades in a leaf-type shutter.

In the screw-mount Leicas, the escapement sits at the bottom of the camera. There are two retard levers connected by a long rod — the **upper retard lever** at the top of the camera and the **lower retard lever** at the bottom of the camera. The upper retard lever intercepts the closing-curtain cam; the lower retard lever straddles or strikes a pin on the first-gear segment of the escapement, Fig. 50.

The upper retard lever doesn't touch the closing-curtain cam on the intermediate and fast speeds — the slit-width speeds. Here, the upper-retard-lever spring holds the upper retard lever away from the retard lobe on the closing-curtain cam, Fig. 50. For the slow speeds, the upper retard lever must move toward the closing-curtain cam — that's the function of the **slow-speed cam** on the back of the slow-speed knob, Fig. 51.

Selecting a slow speed turns the slow-speed cam. The slow-speed cam then pushes the retard rod toward the back of the camera. **And the retard rod carries the upper retard lever into the path of the retard lobe of the closing-curtain cam.** The upper-retard-lever spring makes sure that there's firm contact between the retard rod and the slow-speed cam.

Now, consider that the opening curtain has just released the closing curtain. The closing-curtain cam moves a slight distance before striking the upper retard lever. This slight rotation isn't enough to allow the closing curtain to enter the picture area. So the shutter remains open until the closing-curtain cam is able to push the upper retard lever out of its way. Once the closing-curtain cam gets by the upper retard lever, the closing curtain zips across the focal-plane aperture to end the exposure.

The time it takes for the closing-curtain cam to push its way past the upper retard lever depends on the speed setting. Setting a slower speed pushes the upper retard lever into deeper engagement with the closing-curtain cam. So it takes that much longer for the closing-curtain cam to push the upper retard lever aside.

Keep in mind that the closing curtain is moving during the entire slow exposure. But, because of the escapement, it's moving very slowly. And the closing curtain can't get far enough to enter the aperture until it pushes the upper retard lever completely out of the way.

THE LEICA - TYPE SHUTTER

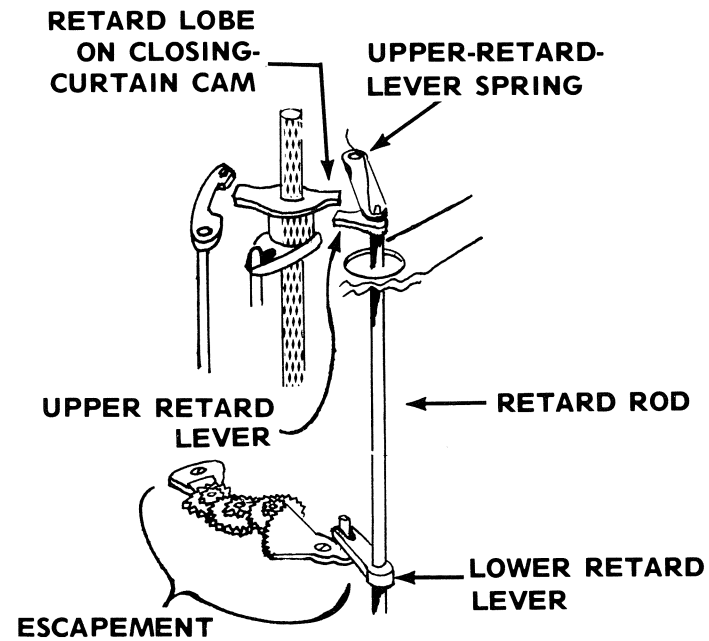

FIGURE 50

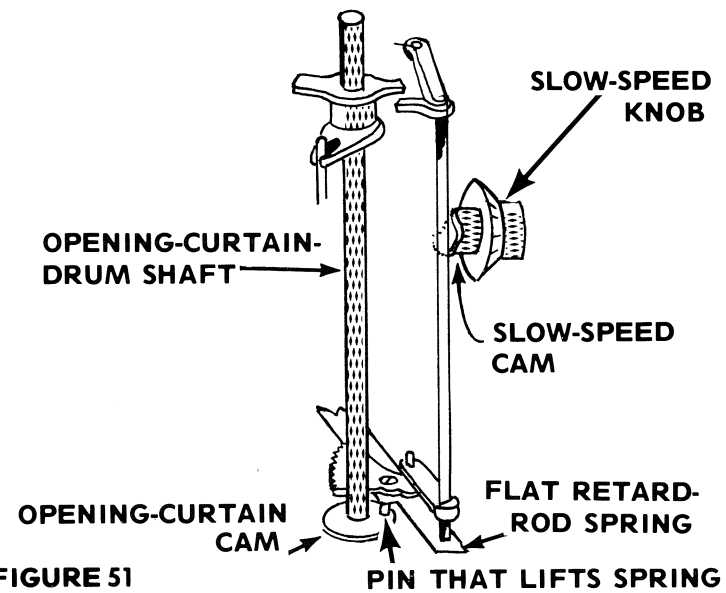

FIGURE 51

Flash Synchronization With a Focal-Plane Shutter

Most self-capping focal-plane shutters have internal flash synchronization. In earlier lessons, you've seen how a leaf-type shutter closes a pair of contacts automatically. But the focal-plane shutter introduces some new problems in synchronizing a flashbulb or electronic flash with the shutter operation.

Remember, the focal-plane shutter provides fast speeds by exposing only a part of the film at a given time. So you can just use an electronic flash at certain speeds — those speeds which expose the entire frame at once. The reason is that the burst of light from an electronic-flash unit is brief. If you use an electronic flash at a slit-width speed, you'll expose only that section of the film uncovered by the slit at the moment the flash fires.

Is that a problem? It can be. With most focal-plane shutters, the fastest full-aperture speed is 1/30 second or 1/60 second. In a few, you can use 1/125 second. If there's not too much additional light around, you'll never know the difference — the flash stops the action. But if there is some extra light, the slow shutter speed could result in a ghost image — an available-light image on the same frame as the flash image.

So you can't use an electronic-flash unit on the slit-width speeds. Nor can you use a conventional flashbulb. Rather, you need a special flashbulb that retains its maximum light output for a longer time — FP (focal-plane) flashbulbs. The exposure reaching any one part of the film at a given time may be brief, depending on the slit width. But it still takes a relatively long time for the slit to completely cross the picture area. The flashbulb must provide a constant amount of light during the entire period that the curtains are in motion; that assures that each part of the film will get the same exposure.

The Leica-Type Shutter — Most Common Self-Capping Design

There are several different kinds of shutters operating on a similar principle. But one particular self-capping design is so popular that we can consider it a basic type. It's called the Leica-type shutter after its originator. And it covers in theory most of the self-capping focal-plane shutters you'll be servicing.

Many of the now-standard concepts in photography came with the introduction of the Leica. In fact, the entire field of 35mm photography became reality when Oskar Barnack built his original prototype, an unnamed camera designed to use 35mm motion-picture film. That camera became the Leica, and Leitz became the manufacturer.

Leitz pioneered such features as coupled film-and-shutter wind and daylight-loading cassettes. But perhaps their most outstanding contribution to camera design has been the self-capping focal-plane shutter. Barnack's prototype used a fixed-slit, variable-tension,

THE LEICA - TYPE SHUTTER

focal-plane shutter. However, the first production Leica — the Model A — features the self-capping design.

The Model B, introduced around the same time as the Model A, has a leaf-type shutter. While both the B and the A have considerable value as antiques, the Model B is a real oddity — it's the only production Leica that doesn't have a self-capping focal-plane shutter.

From there, Leitz proceeded to improve the Leica until the camera became a standard of excellence. The screw-mount Leicas, Fig. 7 (A), include several models using interchangeable lenses with screw-in mounts — that's a carryover from the influence of the motion-picture cameras from which Barnack borrowed the film format. A second series — the M-series Leicas, Fig. 7 (B) — switched to a bayonet-type lens mount.

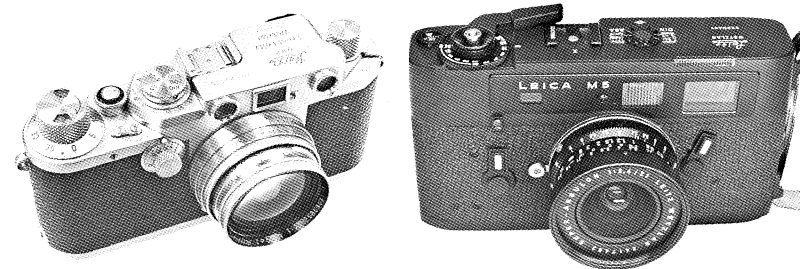

FIGURE 7 SCREW-MOUNT LEICA
A

THE M5, ONE OF THE M-SERIES LEICAS
B

Cameras from the screw-mount series look quite a bit different from those in the M-series — that's obvious in Fig. 7. But they're not so different inside. All models in both series feature the self-capping focal-plane shutter, the same shutter we'll be discussing in this lesson.

The standard Leica pattern of compact rangefinder-type cameras finally got a jolt with the introduction of the Leicaflex. The Leicaflex is a highly refined single-lens reflex. Yet even this camera continues in the tradition set by the Model A. The heart of the Leicaflex is the now-familiar self-capping focal-plane shutter, proving the shutter's technical excellence in the most modern of cameras.

In addition to the popular Leica, there've been several close copies manufactured in different countries. Often the American, British, Russian, and Japanese copies have been nearly feature-for-feature identical to the German-made Leica. Most of the copies have since fallen by the wayside. But the Leica continues to flourish. And the self-capping focal-plane shutter pioneered by Leitz has become the shutter most frequently used in modern single-lens reflex cameras.

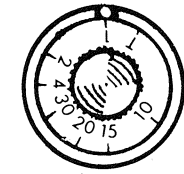

SLOW-SPEED KNOB (FRONT OF CAMERA)

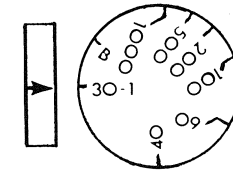

SPEED KNOB (TOP OF CAMERA)

FIGURE 49

1 SECOND

In principle, you could hold open the shutter for any length of time. However, the mechanical escapement has its limitations in the amount of retard it can provide. The slowest speed with a self-capping focal-plane shutter using a mechanical escapement is normally 1 second. Some cameras provide even slower speeds by using an additional escapement for mechanically timed "bulb" exposures. But the electronically controlled shutter tops them all when it comes to providing slow speeds — some can stay open for several seconds, or even minutes, with exacting accuracy.

THE LEICA - TYPE SHUTTER

The Leica Slow-Speed System

The slow-speed system provides the speeds slower than the full-aperture speed. Here, most focal-plane shutters use a conventional escapement; some use an electronic timing system. But the result is still the same — the closing curtain remains in the wound position for the length of the exposure.

In the screw-mount Leicas, a separate **slow-speed knob** on the front of the camera controls the running time of the escapement. Use the slow-speed knob to select any exposure longer than the full-aperture speed.

For example, suppose that the full-aperture speed is 1/30 second. To get 1/30 second, set both the speed knob (on top of the camera) and the slow-speed knob (on front of the camera) to 1/30 second. When you release the shutter, the opening curtain moves completely across the focal-plane aperture and releases the closing curtain. For a faster exposure, leave the slow-speed knob at 1/30 second and position the speed knob at the setting you want, Fig. 48.



FIGURE 48 1/100 SECOND

Setting the slow-speed knob to 1/30 second disengages the escapement — it can't interfere with the operation of the closing curtain. But at any other setting, the slow-speed knob shifts the escapement into action.

Say you want a speed slower than 1/30 second. First, you must select the full-aperture speed on the speed knob — in our example, 1/30 second. The calibration for 1/30 second — 30-1 — means that you must use this setting for all speeds of 1/30 second through 1 second.

Next, turn the slow-speed knob to the desired setting, Fig. 49. When you now trip the shutter, the opening curtain completely crosses the aperture and trips the closing curtain. But the closing curtain can't as yet enter the aperture — it's held back by the escapement.

There are several advantages in using a focal-plane shutter in a single-lens reflex. You'll recall that using a leaf-type shutter requires a mechanism to hold open the blades for through-the-lens viewing and focusing. Yet a focal-plane shutter sits behind the mirror. So it can't interfere with the light path to the focusing screen. Also, the focal-plane-shutter design simplifies the mirror-operating mechanism — the mirror simply trips the opening curtain.

Another type of self-capping focal-plane shutter used frequently in single-lens reflexes is the Copal Square. In design, the Copal Square shutter is quite a bit different from the Leica-type shutter — though the principles basic to focal-plane shutters remain the same.

The name "Copal" should sound familiar to you. Remember, Copal makes several models of leaf-type shutters. As with their leaf-type shutters, Copal makes the Copal Square as a completely modular unit — it then sells the shutter module to different camera manufacturers. Rather than using two curtains traveling horizontally, the Copal Square has two sectioned metal blades operating vertically. There are advantages. The blades travel the short distance across the aperture — from top to bottom — rather than the long route. And they provide a full aperture at all but the three fastest speeds. So you can use electronic flash at faster speeds than you can with conventional focal-plane shutters.

By contrast, the Leica-type shutter is an integral part of the camera. It's made by the camera manufacturer — not purchased as a module from another manufacturer. As a result, you'll find many variations in actual construction among the different cameras using the Leica-type shutter. For example, although most Leica-type shutters use cloth curtains, extremely thin metal curtains can do the same job; the Nikon and the Canon F-1 have metal (titanium) curtains.

Despite variations and refinements, however, all Leica-type shutters work on basically the same principle. So it's important that you learn the basic design. You'll then find that all Leica-type shutters are nearly identical, even though the shapes and locations of the parts may vary. And you'll be able to figure out any Leica-type shutter — even if you've never before seen the camera. Just identify the unfamiliar parts with the functions you know must take place.

THE LEICA - TYPE SHUTTER

Basic Operation of the Leica-Type Shutter

Perhaps the best way to understand the Leica-type shutter is to build one from scratch. We'll start with a part you've already seen — the curtain, Fig. 8. When we've finished, we'll have the shutter used in the Leica IIIf, Fig. 7 (A). Remember, that's the self-capping focal-plane shutter which inspired all the others.

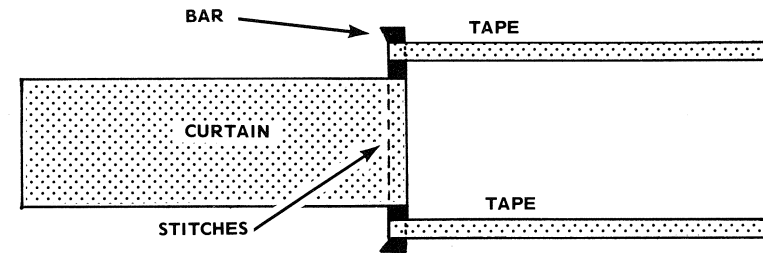

FIGURE 8

The curtains form the heart of the self-capping focal-plane shutter. All the other parts, complex though they may at first appear, have only one function — moving the curtains across the focal plane.

Both curtains in the Leica IIIf are identical. They're made of cloth which is rubberized on one side — the rubber coating makes the curtains completely opaque. The end of each curtain folds over its own flat, metal bar with the rubberized side facing the bar. The curtains are cemented to the bars; then, they're sewn with black, nylon thread for additional strength.

Nylon tapes attach to the ends of the curtain bars in the same manner, Fig. 8. These tapes pull the curtains across the focal-plane aperture.

Replacing the curtains in a Leica-type shutter is a common repair — a repair you'll perform many times as a camera-repair technician. The tapes can break or the cloth can wear and deteriorate as a result of age and use. A broken tape is easy to spot; deterioration takes a little practice. One way is to examine the material while holding the curtain against a light source — look for tiny pin holes, a sure sign of deterioration. The little holes will eventually become big holes. And light will find an unintended route to the film.

But more often, you'll be replacing curtains because of a mistake made by the camera owner. Holes in the curtain material frequently result from the owner's probing in the focal-plane aperture with a pointed object, perhaps to remove a film chip. Or the owner may actually burn a hole in the cloth curtain by leaving the camera lens-up in open sunlight.

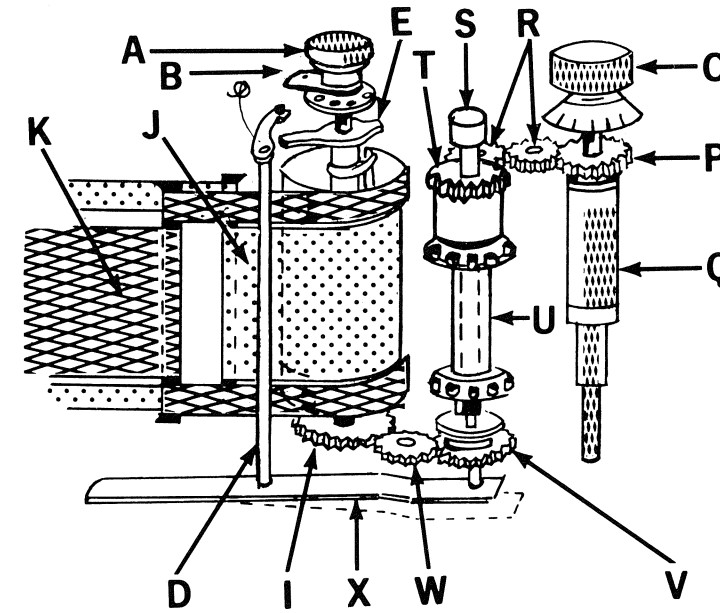

(B)

- | | |
|-----------------------------------|-----------------------------|
| A. SPEED KNOB | O. WIND KNOB |
| B. DISENGAGING LEVER | P. FILM-TAKE-UP-SLEEVE GEAR |
| C. SPEED-CONTROL PLATE | Q. FILM TAKE-UP SLEEVE |
| D. CLOSING-CURTAIN LATCH | R. FILM-WIND IDLER GEARS |
| E. CLOSING-CURTAIN CAM | S. RELEASE PLUNGER |
| F. OPENING-CURTAIN DRUM | T. SPROCKET GEAR |
| G. CLOSING-CURTAIN DRUM | U. SPROCKET |
| H. STATIONARY STOP PIN | V. FIRST-CURTAIN-WIND GEAR |
| I. DRUM GEAR | W. CURTAIN-WIND IDLER |
| J. CLOSING CURTAIN | X. FLAT RELEASE SPRING |
| K. OPENING CURTAIN | |
| L. GUIDE ROLLERS | |
| M. OPENING-CURTAIN TAKE-UP ROLLER | |
| N. CLOSING-CURTAIN TAKE-UP ROLLER | |

THE LEICA - TYPE SHUTTER

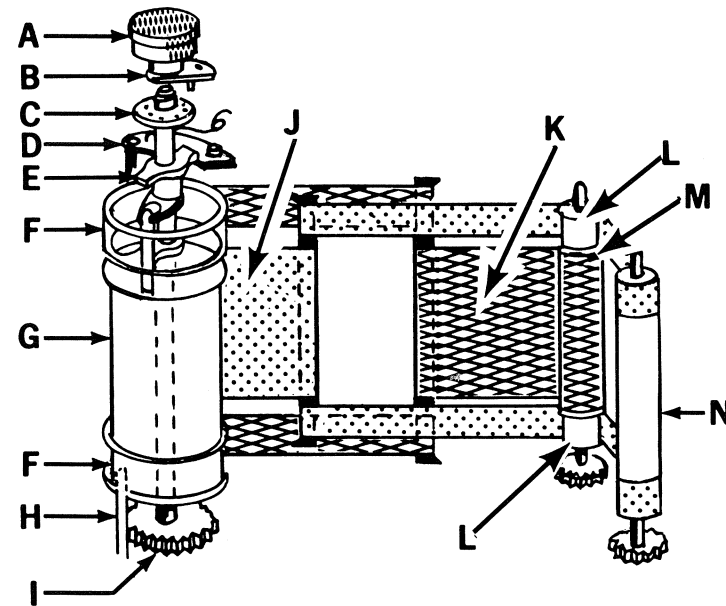

FIGURE 47 (A)

In its basic form, our Leica-type shutter is now complete, Fig. 47. The shutter offers a range of shutter speeds — perhaps from 1/20 or 1/30 second (the full-aperture speed) to 1/1000 second (the smallest slit). What more could we want? Well, we still don't have the slow speeds. For these, we must add a retard mechanism.

Burn a hole? That seems hard to imagine. But it's the all-too-common result of leaving the camera for a period of time with the uncovered lens facing the sun — perhaps on the window ledge in the back of a car. As you know, an image is made up of all the point sources of light coming from the object. If any one point is of sufficient intensity — such as from a luminous source — it can burn the cloth in a short time. In effect, the camera lens acts as the magnifying glass described in your lesson, "Optics for the Camera Technician."

When curtain damage results from an accident, it's sometimes possible to save time in an emergency by patching the curtain. But if you can see pin holes in the material, it means only one thing — the material is deteriorating and you must replace the curtain.

How about the titanium curtains? Well, they can stand greater stress than can the cloth curtains. And they don't seem to wear out or deteriorate. But you'll still be replacing them. Probing fingers in the focal-plane aperture can cause instant damage. The tissue-thin titanium crinkles permanently at the slightest misdirected touch.

Making New Curtains

You can purchase most curtains as factory-made replacements. But you may nonetheless have to make new cloth curtains — for example, when working on outdated or unusual cameras for which parts aren't available. Here, you may obtain bulk curtain material which you can cut to the specifications of the particular camera.

Remember that the curtains are directly responsible for the exposure. So you must use extreme care and precision in their manufacture. **Make the curtain cuts as square, clean, and straight as possible.** A new single-edged razor blade used with a straight edge works well for cutting the curtains to size from the bulk material.

Since the material is rubberized on one side, it can stretch in the direction of the cloth's weave. **Make your lengthwise cuts against the weave of the material — in the direction the cloth will not stretch.** Once the curtains are in the camera, they'll get pulled from both ends. If they can stretch, their length will change as soon as you apply the tension.

Whenever you make new curtains, use the old ones as patterns. Make the replacements to the same dimensions. But be sure to leave enough extra length to allow folding the cloth over the bars — 5/16" is sufficient for the fold.

You can usually reuse the original bars. But if the bars are damaged, make new ones from hard brass or common black iron sheet. Cut the bars to the same measurements as the originals. And

THE LEICA - TYPE SHUTTER

paint the bars with a dull black lacquer before attaching the curtains.

One of the most critical steps in curtain manufacture is the folding of the material around the bars. **Each curtain must be perpendicular to its bar.** If the curtains aren't square, a tapered slit will move across the focal-plane aperture, Fig. 9. So the top of the film frame gets either a faster or a slower shutter speed than the bottom, depending on the direction of the taper.

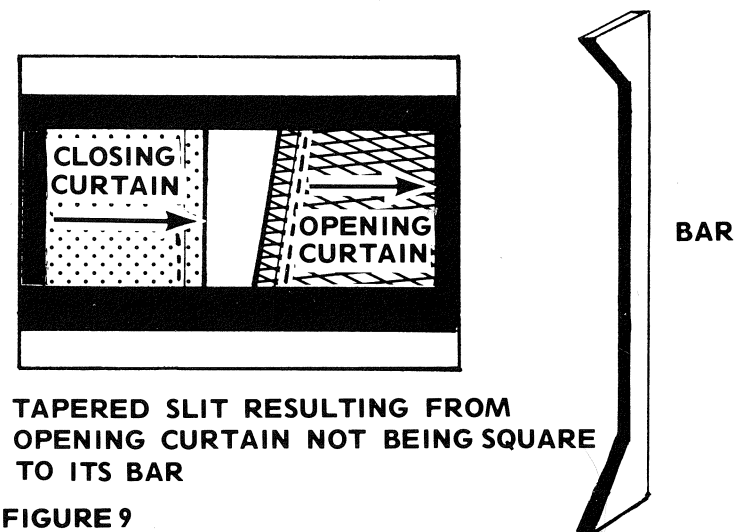

Apply a light coat of shellac or rubber-base cement (such as Pliobond) to the bars. Then, carefully align the curtains in position. While the cement is drying, you can make precise adjustments to the squareness of the curtains.

Next, hand sew the curtains to the bars — **keep your stitches within 1/32" of the bars.** Don't use a machine for sewing the curtains; the sewing machine frequently "puckers" the material between each stitch, preventing the curtains from lying flat in the focal plane. Cut the tapes to length and attach them to the bars using the same procedures.

Curtain Positions in the Camera

In some cameras, the two curtains are different in size — then, you must be careful to identify which is which. But in the Leica IIIf, there's no problem; both curtains are the same.

SHUTTER SET AT 1/200 SECOND



FIGURE 46

Since the speed knob attaches to the disengaging lever, it always rotates with the opening-curtain drum. The rotating speed knob results in a different shutter-speed calibration aligning with the index when the shutter's cocked than when the shutter's released. Always cock the shutter before setting the shutter speed. Once you've tripped the shutter — and the speed knob has rotated a partial turn (not a full 360 degrees) — you'll find that the shutter-speed calibration no longer aligns with the index, Fig. 46.

THE LEICA - TYPE SHUTTER

You've already seen how the shutter operates on "bulb." In order for the shutter to stay open, the disengaging lever must not strike the closing-curtain latch. So at "bulb," the disengaging lever sits at its maximum distance from the closing-curtain latch (once the shutter's cocked), Fig. 44. Here, the disengaging lever can't travel far enough to trip the closing curtain.

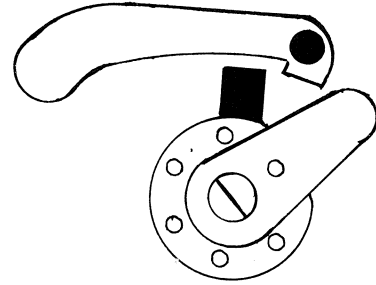
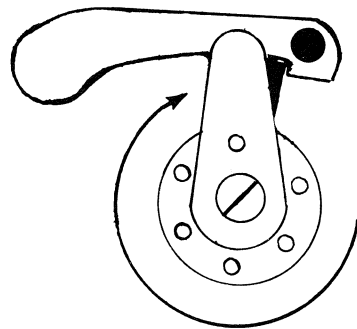

FIGURE 44 SHUTTER COCKED, SET AT "BULB"

Fig. 45 shows what happens when you release the shutter at "bulb." The opening curtain has crossed the picture area. And the stop pin at the bottom of the camera has arrested the opening-curtain drum. But the disengaging lever is still a little short of the stud on the closing-curtain latch. So the shutter remains open until you let up the release plunger; then, the flat release spring pushes up the closing-curtain latch to free the closing curtain.



**FIGURE 45 OPENING CURTAIN RELEASED ON "BULB" —
DISENGAGING LEVER CAN'T TRAVEL FAR
ENOUGH TO REACH CLOSING-CURTAIN LATCH**

Fig. 10 shows the positions the curtains normally occupy in the camera. Notice that the curtains extend in opposite directions. The tapes of the closing curtain point to your right, as seen from the front of the camera. And the tapes of the opening curtain point to your left.

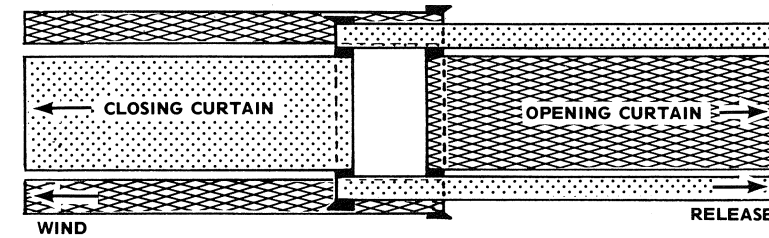

FIGURE 10

So the rubberized side of the closing curtain and the cloth side of the opening curtain face the film area. And the curtain hems face one another. For illustration clarity, our drawings are slightly out of proportion. We're showing the opening-curtain bar as being longer than the closing-curtain bar. But the two bars are actually the same.

When you wind the curtains from right to left, the opening curtain is pulled by its tapes. The closing curtain is pulled directly by the cloth. On the release cycle, just the reverse is the case. During the right-to-left travel, the curtains overlap the width of one bar, Fig. 11. You'll recall that this overlap prevents light from reaching the film during the cocking cycle.

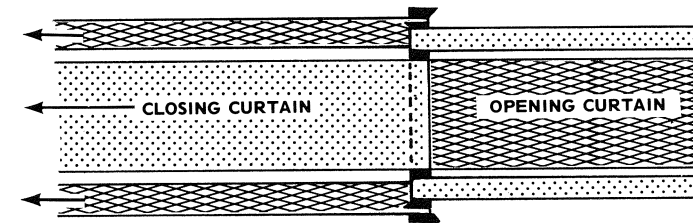

FIGURE 11 CURTAINS OVERLAPPED DURING WIND

Now, imagine that there are two separate springs at the right-hand end of the camera. One spring attaches to the closing-curtain tapes and the other spring hooks to the opening-curtain cloth. Let's say that both springs tend to pull the curtains from left to right.

If you grasped the opening curtain by its cloth — and simultaneously grasped the closing curtain by its tapes — you could pull both curtains to your left with the bars overlapped. That's what

THE LEICA-TYPE SHUTTER

happens on the winding cycle. The right-to-left movement tensions the two springs. When you then release your grip, the springs pull the curtains from left to right. Suppose that you released both curtains at the same time; they would then snap back in unison.

But you could let go of the opening-curtain tapes while still holding the closing curtain. The opening curtain would then return to the right, unmasking the focal-plane aperture. If you next released the closing curtain, it would follow the opening curtain to cover the aperture.

You could even control the slit width — just release the closing curtain before the opening curtain completely crosses the aperture. The slit depends on how far the opening curtain travels before you let go of the closing curtain. That's really how the shutter acts in the camera. All we have to add are the parts to wind the curtains from right to left and the springs to return the curtains from left to right.

The Take-Up Rollers

The parts that return the curtains are the spring-loaded **take-up rollers** mounted in bearings at the right-hand end of the camera (still looking at the camera from the front). The springs are internal, Fig. 12. Each tends to turn the outer shell of the take-up roller around the stationary central shaft.

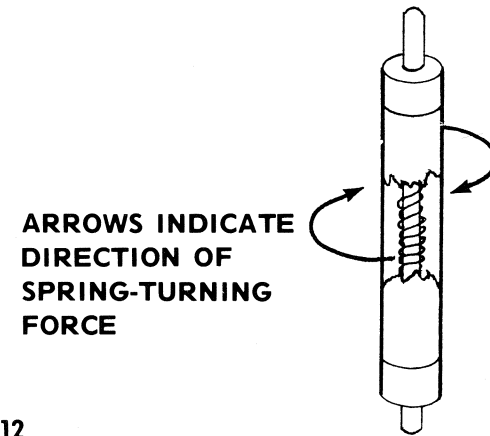

FIGURE 12

Although identical in operation, the two take-up rollers are different in design. The reason is that the tapes of the closing curtain attach to the ends of one take-up roller; while the opening curtain attaches directly to the central portion of the second take-up roller, Fig. 13. Again, shellac or a rubber-base cement holds the curtains to their respective take-up rollers.

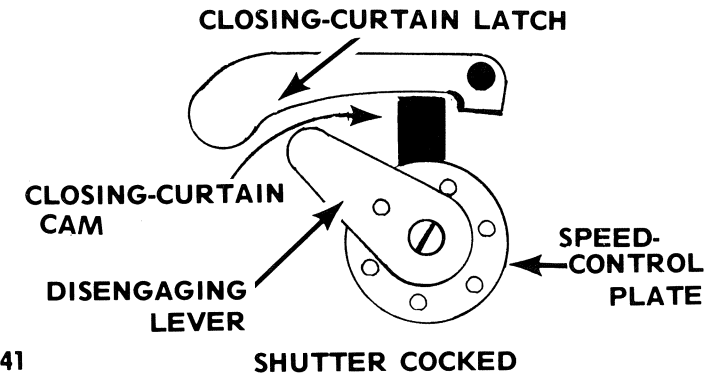
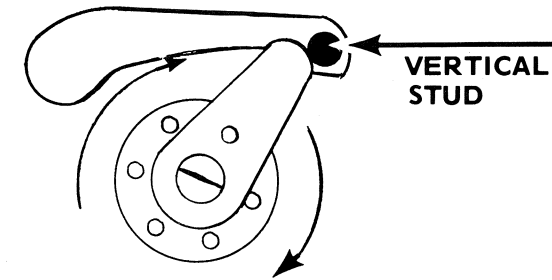

FIGURE 41



OPENING CURTAIN RELEASED, CLOSING-CURTAIN CAM HELD BY CLOSING-CURTAIN LATCH (ARROWS INDICATE ROTATION ON RELEASE CYCLE)

FIGURE 42

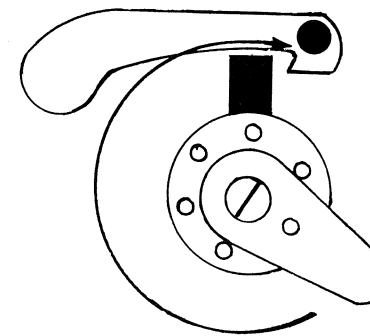

FIGURE 43 SHUTTER COCKED, SET AT SLOWEST SPEED

THE LEICA-TYPE SHUTTER

The speed knob (the knob that you use to select the shutter speed) attaches directly to the disengaging lever, Fig. 40. To change shutter speeds, you first lift the speed knob — that raises the disengaging lever far enough that its pin clears the holes in the speed-control plate. Then, you turn the speed knob in either direction to align the desired speed calibration (on the knob) with an index (on the top of the camera). Finally, allow the speed knob to drop down — it's spring-loaded, so it snaps into place. The pin on the disengaging lever then drops into the particular hole which corresponds to the shutter-speed calibration.

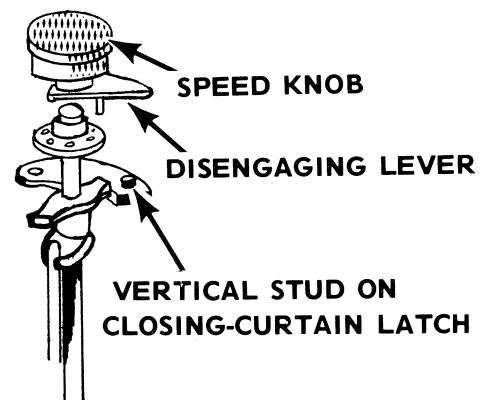

FIGURE 40

When you release the shutter, the speed-control plate turns with the opening-curtain drum. And the disengaging lever spins in the same direction. At the proper point in the opening curtain's travel, the disengaging lever strikes the vertical stud of the closing-curtain latch, Fig. 40. Exactly when the closing curtain releases depends on the position of the disengaging lever — how close it sits to the closing-curtain latch with the shutter cocked.

For example, assume that you've cocked the shutter and set the shutter speed. Now, the disengaging lever sits at a fixed position with respect to the stud on the closing-curtain latch, Fig. 41. When you release the shutter, the opening-curtain drum carries the speed-control plate in a clockwise direction as the opening curtain starts moving.

The speed-control plate carries the disengaging lever in the same direction. And when the opening-curtain drum has turned far enough, the disengaging lever strikes the vertical stud on the closing-curtain latch, Fig. 42; that kicks the closing-curtain latch away from the closing-curtain cam to free the closing curtain.

If you want a faster speed, you just set the disengaging lever further clockwise in Fig. 41. And for a slower speed, move the disengaging lever counterclockwise. At the slowest speed, Fig. 43, the disengaging lever is so far away from the closing-curtain latch that it can't free the closing curtain until the opening curtain completely crosses the aperture.

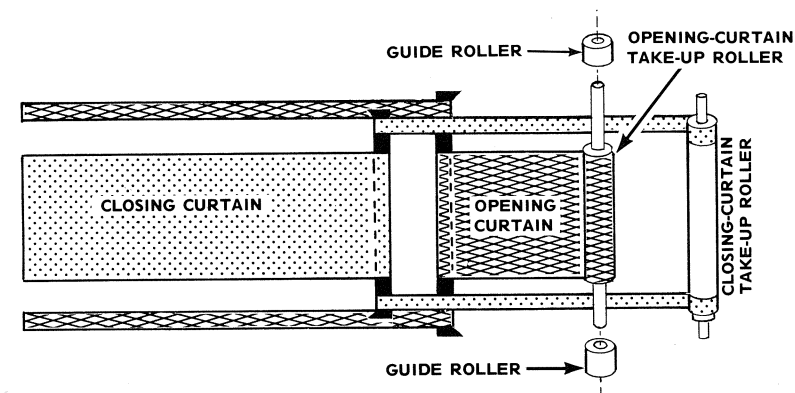

FIGURE 13

Releasing the opening curtain allows the opening-curtain take-up roller to spin. So the opening curtain wraps around the outer shell. When you release the closing curtain, the closing-curtain take-up roller rotates in the same direction. And the closing-curtain tapes wrap around the ends of the take-up roller.

Fig. 14 shows how the take-up rollers fit in the camera. The closing-curtain take-up roller sits directly in front of the opening-curtain take-up roller. Notice that the two closing curtain tapes must pass around the opening-curtain take-up roller to reach the closing-curtain take-up roller. The closing-curtain tapes run on two free-turning **guide rollers**. And the guide rollers slip over the ends of the opening-curtain take-up roller. As the closing curtain crosses the focal plane, its tapes run freely on the guide rollers.

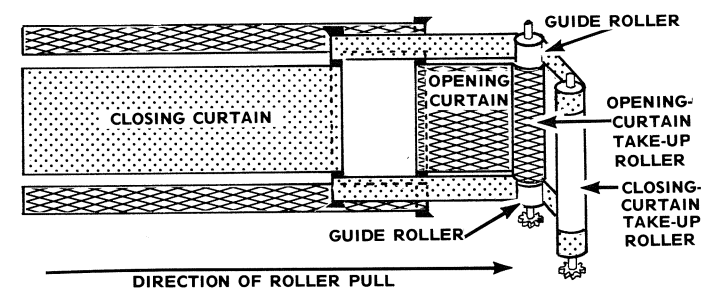

FIGURE 14

With the shutter cocked, both curtains lock at the left-hand end of the focal plane — against the spring tension of each take-up roller. Then, on the release cycle, the two take-up rollers pull their curtains

THE LEICA - TYPE SHUTTER

across the aperture — first the opening curtain, and then the closing curtain at a predetermined time lapse. That's the only purpose of the take-up rollers. The mechanism that winds the curtains, locks them in position, and times their release is at the other end of the camera. In a moment, we'll put together the control mechanism.

But first, let's take a closer look at the take-up rollers. Fig. 15 shows how each take-up roller looks inside. In operation, the central shaft which hooks one end of the spring does not turn. The other end of the spring hooks to the outer shell; so the spring turns the outer shell around the central shaft.

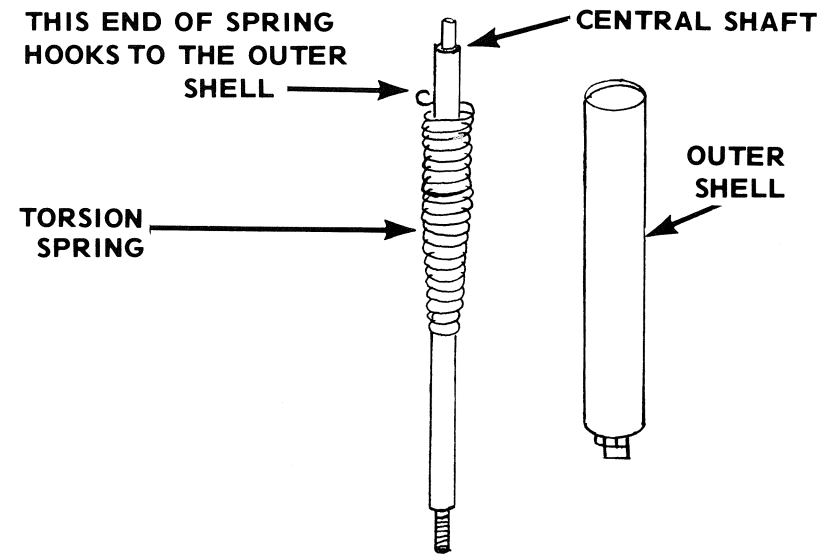

DESIGN OF CLOSING-CURTAIN TAKE-UP ROLLER
FIGURE 15

You must apply a certain amount of initial tension to the spring before you lock the central shaft in place. This initial tension is critical — it determines how fast the curtain travels when you release the shutter.

There are several methods used to lock the central shaft of each take-up roller. But all methods provide a means for adjusting the initial tension; the adjustment is your control for setting the curtain speed. You know that the two curtains operate independently — and the speed each curtain travels is determined by the initial

Assume for a moment that you just want one instantaneous speed — maybe 1/60 second. All you'd have to do is attach a lever to the top of the opening-curtain-drum shaft. Position the lever at such an angle that it strikes the closing-curtain latch once the opening-curtain drum has rotated a certain distance.

If you want the fastest speed, position the lever so it will strike the closing-curtain latch as soon as the opening-curtain drum starts to move. Here, the lever must sit very close to the closing-curtain latch when the shutter's in the cocked position. Or, for the slowest speed, position the lever so it strikes the closing-curtain latch once the opening curtain clears the focal-plane aperture.

But the Leica has several speeds. A simple lever attached directly to the shaft won't do. What we need is a disengaging lever which can be positioned in several precise locations relative to the closing-curtain latch.

So the Leica has a **speed-control plate**, Fig. 38, attached to the opening-curtain-drum shaft. There's a series of holes in the speed-control plate. Each hole corresponds to a certain slit width. The **disengaging lever** then sits over the top of the speed-control plate. A pin on the underside of the disengaging lever fits into one of the speed-control-plate holes, Fig. 39.

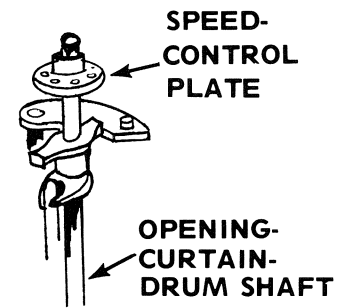

FIGURE 38

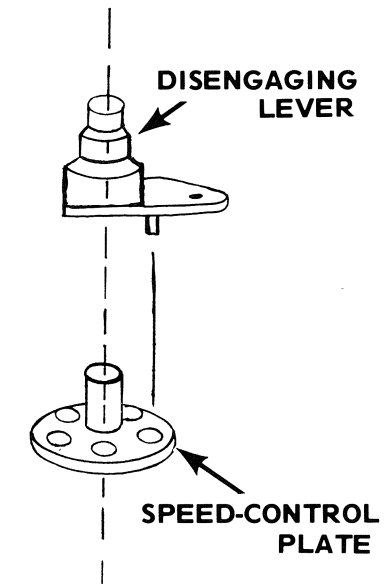

FIGURE 39

THE LEICA - TYPE SHUTTER

What you've just seen is the sequence at "bulb" operation. The shutter stays open as long as you hold down the release plunger. In fact, if you wanted to design a shutter that delivered only "bulb," you wouldn't have to add anything more. The shutter's complete. But for instantaneous speeds, we still need a system for disengaging the closing-curtain latch at some point during the travel of the opening curtain.

We've mentioned that the opening curtain, in effect, winds the closing curtain. In a similar sense, the opening curtain releases the closing curtain for instantaneous speeds. What part could be better qualified? The opening curtain knows how far it has traveled; so it knows when the closing curtain should start to follow.

The sooner the opening curtain trips the closing curtain, the faster the resulting shutter speed. For a slow speed, the opening curtain completely crosses the aperture before it releases the closing curtain. That's the slowest speed possible without adding a retard mechanism — the exposure time depends only on the curtain-travel time. And for a fast speed, the opening curtain barely starts to move before tripping the closing curtain. So the closing curtain is just a breath behind the opening curtain — a hairline slit for a fast speed. In between, there's quite a range of shutter speeds available just by changing the slit width.

Besides its vertical movement, the closing-curtain latch can also pivot horizontally, Fig. 37. The closing-curtain-latch spring tends to move the closing-curtain latch in two directions — toward the bottom of the camera and toward the closing-curtain cam. So there are two ways to disengage the closing-curtain latch:

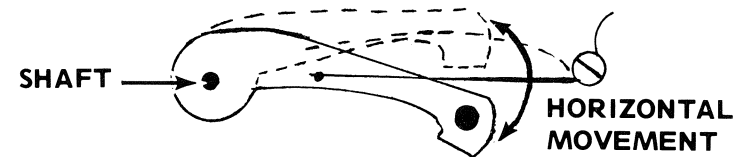

FIGURE 37

1. move the closing-curtain latch above the level of the closing-curtain cam ("bulb" action)
2. push the closing-curtain latch away from the closing-curtain cam (instantaneous speeds).

tension of its own take-up-roller spring. So you must be very precise in setting the initial tensions; the two curtains must travel at the correct speed with respect to one another.

We call the curtain speed the **curtain-travel time**. And adjusting the curtain speed is the **travel-time adjustment**. The curtain-travel time for each curtain is different — one curtain moves faster than the other. If you think back to your last lesson, you can probably see why there's a difference.

Remember acceleration? The curtains have to start from a standstill. They then pick up speed as they travel across the aperture. So in a self-capping focal-plane shutter, the slit does not stay at the same width as it travels. If it did, the last portion of film exposed would receive less light than would the first part. That's because the faster slit travel results in a shorter exposure.

Instead, the slit gets progressively wider as it crosses the focal-plane aperture. It gets wider because the opening curtain travels slightly faster than does the closing curtain.

So in setting the initial tensions, you have two things to consider. First, you want the curtains traveling at the proper speeds for the right exposure. And secondly, you want the curtains traveling at the proper speeds with respect to each other to control the slit width. In your **NatCam Manual #327** on the Leica IIIf, you'll learn one method for setting the initial tensions; you'll learn another in a later lesson. But before you get into actual test methods, you should be aware of the various techniques used to lock the central shafts.

Some Leica-type shutters use a piece of wire which simply slips into a slot at the bottom of each central shaft, Fig. 16. The wire holds the initial tensions. To make an adjustment, first lift the wire out of the slots; then, turn the central shaft in one direction or the other to increase or decrease the tension. The wire-locking technique means you have to turn the central shaft at least 180 degrees for every change in tension — otherwise, the wire won't line up with the slot. Finer adjustments aren't possible.

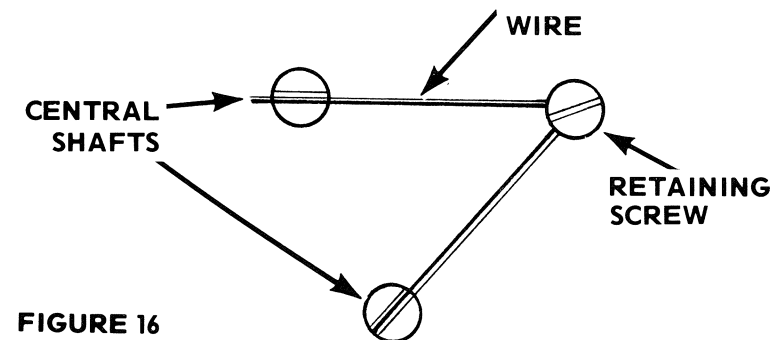

FIGURE 16

THE LEICA - TYPE SHUTTER

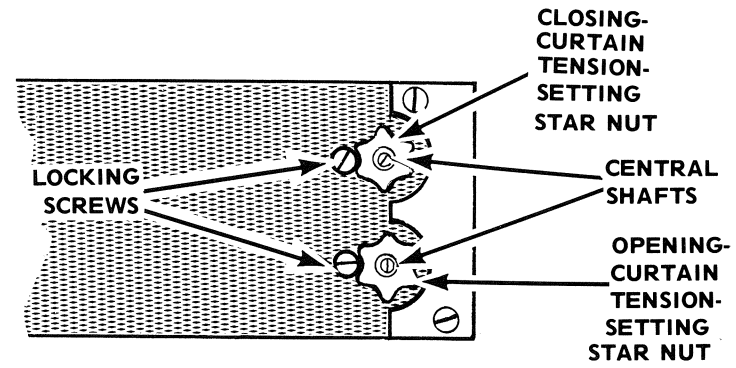

FIGURE 17

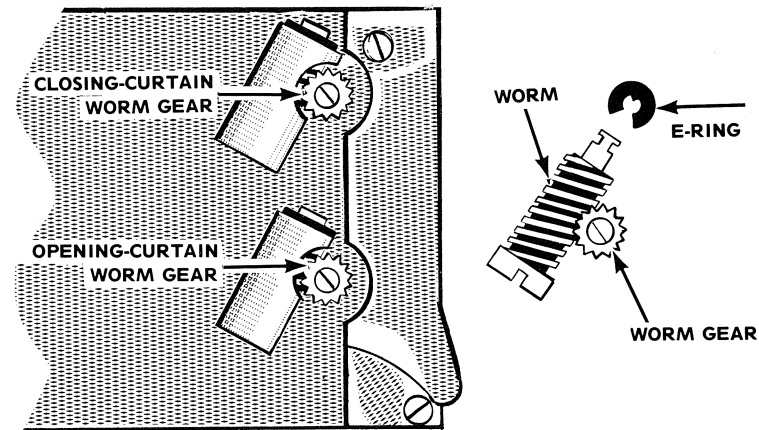

FIGURE 18

Most Leicas use a more sophisticated adjustment technique. In Fig. 17, a tension-setting star nut screws onto the end of each take-up-roller central shaft; a locking screw prevents the star nut from turning. To make an adjustment, first remove the locking screw. Then, turn the star nut in the desired direction.

In later models of the Leica (and in several other cameras), the adjustment is even simpler and more precise, Fig. 18. Rather than the star nut, a **worm gear** screws onto the central shaft. The worm gear engages the **tension-setting worm**; an E-ring (commonly called a C-ring) holds the worm in its casing.

Frequently, a setscrew at the top of the casing locks the tension-setting worm. To adjust the initial tension, first loosen the setscrew.

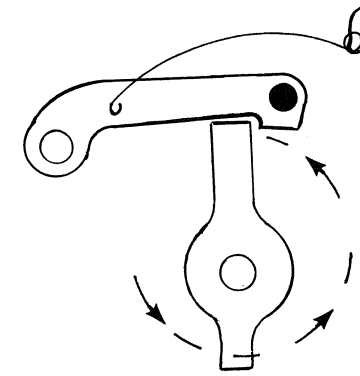

FIGURE 35

SHUTTER COCKED

As you've seen, depressing the release plunger pushes down the flat release spring. And the flat release spring allows the closing-curtain latch to move down. So the moment the opening curtain starts to move, the flat release spring allows the closing-curtain latch to drop into the path of the closing-curtain cam.

The closing-curtain can only move a few degrees before the closing-curtain latch intercepts the closing-curtain cam, Fig. 36. Now, the closing-curtain latch arrests the rotation of the closing-curtain drum — before the closing curtain can enter the aperture. The shutter stays open until you let up the release plunger. Then, the flat release spring pushes up the closing-curtain latch to free the closing-curtain cam.

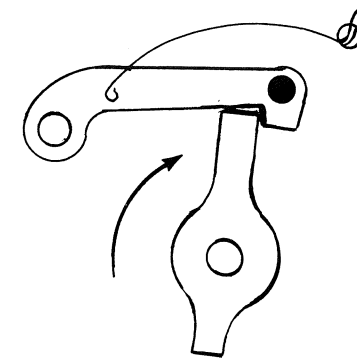

FIGURE 36

OPENING CURTAIN RELEASED

THE LEICA - TYPE SHUTTER

A long shaft riveted to the closing-curtain latch extends to the bottom of the camera. Here, it rests against the flat release spring, Fig. 33. Normally, the flat release spring holds the closing-curtain latch above the plane of the closing-curtain cam. So the closing-curtain cam may rotate freely with the closing-curtain drum from the released position, Fig. 34, to the "ready" position, Fig. 35 — it just passes under the closing-curtain latch.

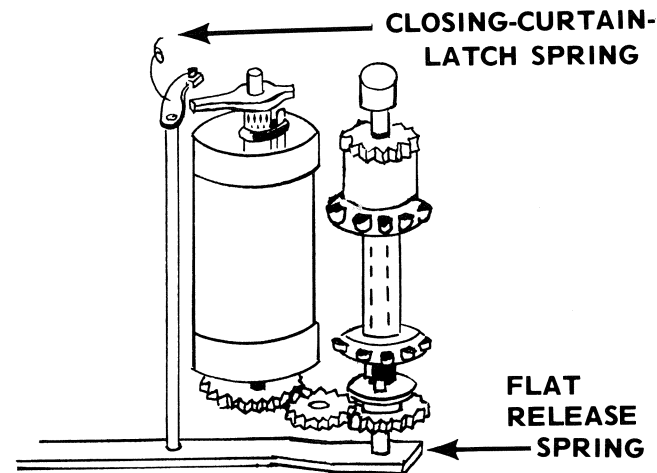

FIGURE 33 FROM BACK OF SHUTTER

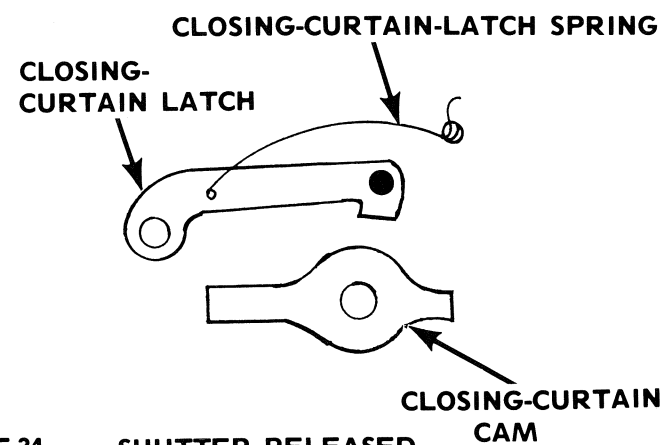

FIGURE 34 SHUTTER RELEASED

Then, turn the tension-setting worm with a screwdriver — clockwise to increase the tension and counterclockwise to decrease the tension. Each full turn of the tension-setting worm rotates the worm gear a relatively small distance. So your adjustment can be very precise. After adjusting the initial tension, be sure to tighten the setscrew.

The Curtain Drum

We now need a method of drawing the curtains to the "ready" position. In effect, we need two winding rollers — one for each curtain.

But rather than two separate winding rollers, the Leica uses a curtain drum, Fig. 19. The take-up rollers sit at one side of the focal-plane aperture — the drum sits at the other. Advancing the film for the next exposure wraps both curtains around the drum.

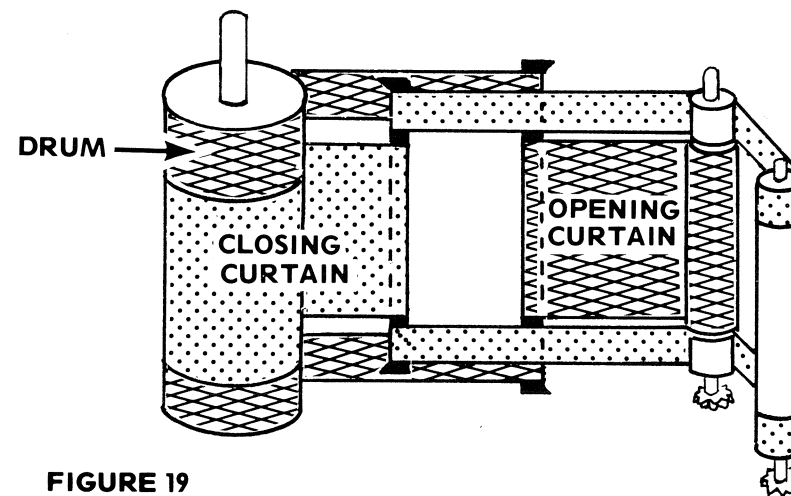

FIGURE 19

The drum winds both curtains at the same time. But it releases the curtains separately. Consequently, the drum has two separate sections — one section that controls the opening curtain and another section that controls the closing curtain. The unique construction of the drum allows both sections to turn simultaneously during the cocking cycle and separately on the release cycle.

THE LEICA - TYPE SHUTTER

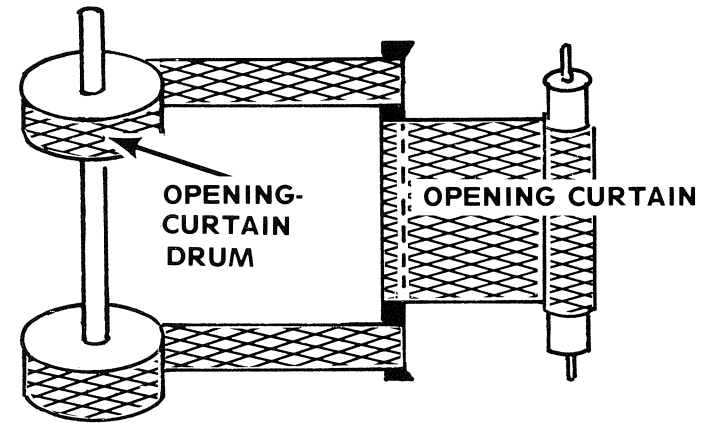

FIGURE 20

If you look closely at a curtain drum, you'll see that the two ends are separated slightly from the center portion. A long shaft connects the two ends of the drum; so the ends turn together. As shown in Fig. 20, the opening-curtain tapes cement to the ends of the drum. Consequently, turning the shaft winds the opening curtain. The section shown in Fig. 20 — consisting of the two ends and the connecting shaft — is the **opening-curtain drum**.

The **closing-curtain drum** is the tubular shell between the two end sections, Fig. 21. As you can see in Fig. 21, the closing curtain cements to the closing-curtain drum. The closing-curtain drum rotates freely between the two ends of the opening-curtain drum, using the long shaft as an axis.

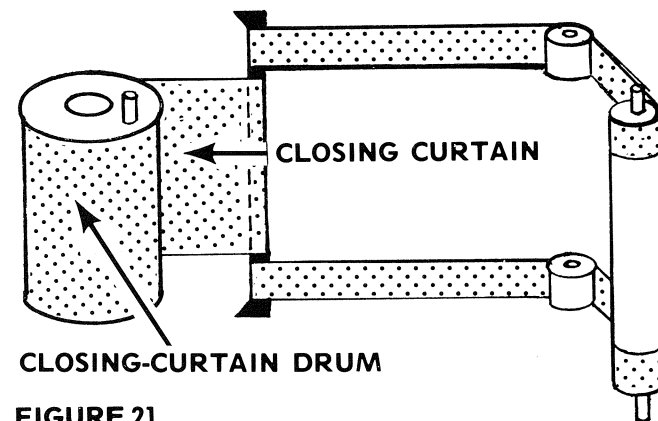

FIGURE 21

18

The stop which arrests the closing-curtain cam is the **closing-curtain latch**, Fig. 32. Consider that you've released the shutter and the opening-curtain drum has just started to turn. The closing-curtain drum starts to follow. But before the closing curtain can enter the aperture, the closing-curtain latch catches the closing-curtain cam. So the closing curtain remains held — and the shutter remains open — until we somehow disengage the closing-curtain latch.

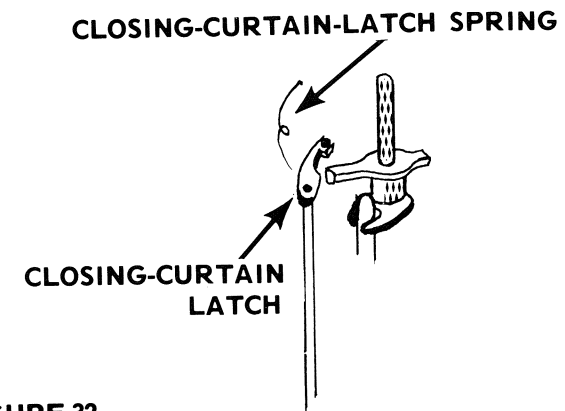

FIGURE 32

27

THE LEICA -TYPE SHUTTER

The Speed-Control Mechanism

The last essential assembly we'll add is the speed-control mechanism. As things now stand, releasing the shutter allows both curtains to fly across the aperture together — there's no slit to expose the film. So we must add a method of holding back the closing-curtain drum after the release of the opening-curtain drum. And we must make the system variable so we can change the release point of the closing curtain.

You've seen that the opening curtain, in effect, winds the closing curtain. That's because the opening-curtain drum engages the pin on the closing-curtain drum. The pin on the closing-curtain drum also provides the means for holding back the closing curtain once the opening curtain starts to move. The speed-control mechanism just blocks the pin; the opening-curtain drum can still rotate freely as its slot passes around the pin.

So let's add the two parts needed to hold back the closing curtain. The first is the **closing-curtain cam**, Fig. 31. The closing-curtain cam slips over the top of the opening-curtain-drum shaft. A fork in the closing-curtain cam then straddles the pin on the closing-curtain drum.

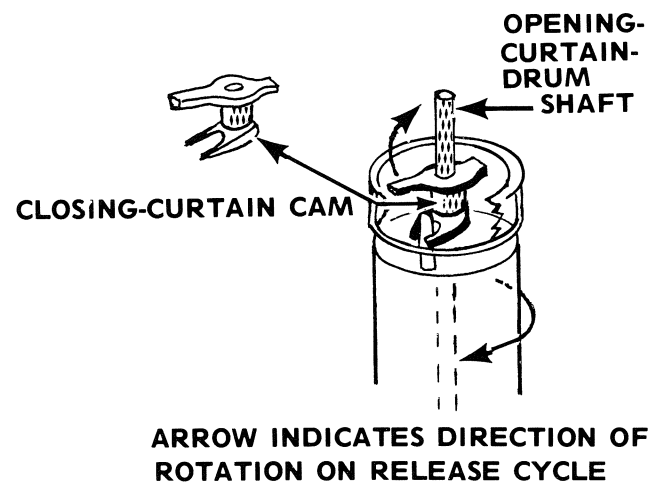

FIGURE 31

As you can see in Fig. 31, the closing-curtain cam and the closing-curtain drum always turn together. Stopping the rotation of the closing-curtain cam also stops the closing-curtain drum. But the opening-curtain drum can still rotate freely — its shaft is smaller than the inside diameter of the closing-curtain cam.

Usually, a screw or a taper pin holds the lower end of the opening-curtain drum to the shaft. So if you're assembling a drum, you'll have to remove the lower end of the opening-curtain drum. You can then insert the shaft through the hole in the center of the closing-curtain drum.

Although the opening-curtain and closing-curtain drums are independent, there's a coupling between the two — there must be in order to wind both curtains simultaneously. Yet the coupling allows the drums to release individually. In effect, the coupling acts as a one-way clutch between the two drum sections. It locks the drums together during the wind cycle and disengages on the release cycle.

Each end of the opening-curtain drum has a slot as shown in Fig. 22. A pin in the top end of the closing-curtain drum fits into the slot in the upper end of the opening-curtain drum, Fig. 23. The travel of the pin within the slot limits the freedom of movement between the two drums. That is, the closing-curtain drum can turn clockwise until its pin strikes one end of the slot — or counterclockwise until its pin strikes the other end.

The slot in the lower end of the opening-curtain drum fits over a fixed stop pin at the bottom of the camera. So the stop pin limits the total rotation of the opening-curtain drum to a partial circle.

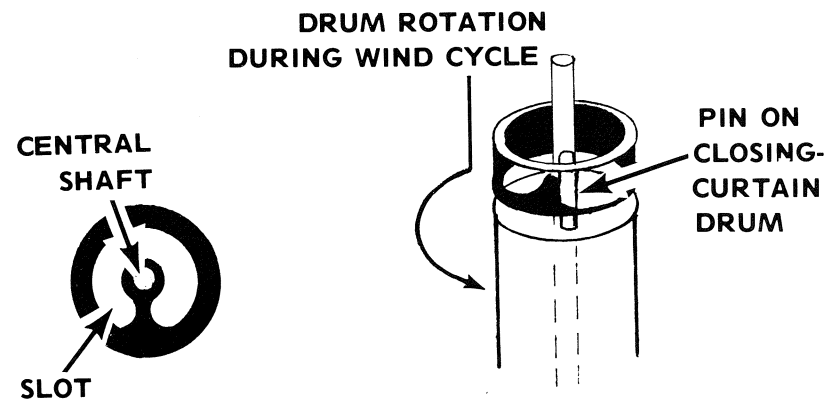

FIGURE 22

FIGURE 23

In the shutter-released position, the opening curtain holds its drum all the way clockwise (as seen from the top) — against the stop pin at the bottom of the camera. If there were no stop pin, the opening-curtain take-up roller could pull the opening curtain too far past the focal-plane aperture. In turn, the closing curtain pulls its drum all the way clockwise. The pin on the top of the closing-curtain drum is then against the end of the slot in the opening-curtain drum,

THE LEICA - TYPE SHUTTER

Fig. 24. Since neither drum can rotate any further clockwise, the curtains rest slightly past the right-hand end of the focal-plane aperture. Here, the curtains overlap by one-bar width.

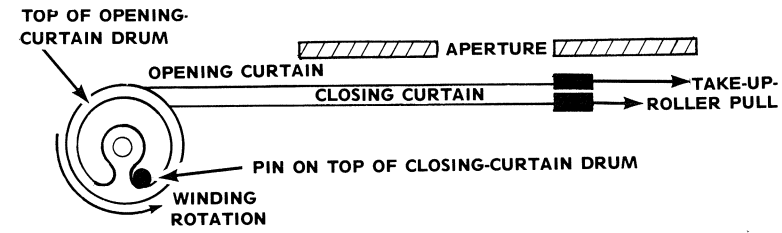

FIGURE 24 RELEASED POSITION

The drum gear, Fig. 25, engages the cocking mechanism to wind the curtains. The drum gear attaches to the opening-curtain-drum shaft. Advancing the film to the next frame simultaneously turns the drum gear. Then, since the drum gear attaches to the shaft, the opening-curtain drum turns in a counterclockwise direction.

As soon as the opening-curtain drum starts turning counterclockwise, its slot comes against the pin of the closing-curtain drum. So the opening-curtain drum turns the closing-curtain drum in the same direction. And the drums pull the two curtains, still overlapped, across the focal-plane aperture. Finally, the stop in at the bottom of the camera arrests the counterclockwise rotation.

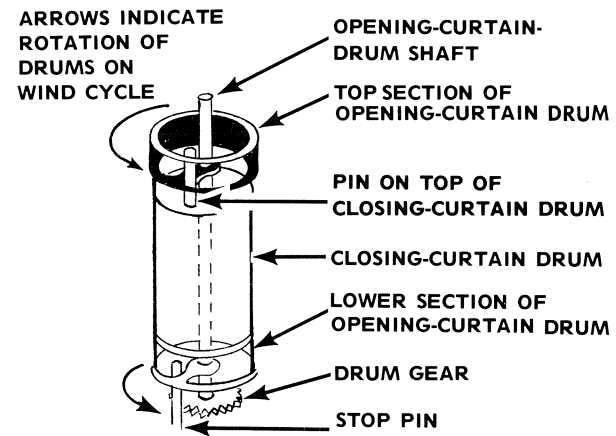

FIGURE 25

When you push down the release plunger — against the pressure of the flat release spring — the first-curtain-wind gear moves down. Now, the stud on top of the first-curtain-wind gear clears the stud on the bottom of the sprocket. So the interlocking studs disengage. And the first-curtain-wind gear turns freely as the opening curtain fires across the aperture in the release direction.

The drum gear, the curtain-wind idler, and the first-curtain-wind gear all spin with the opening-curtain drum. The first-curtain-wind gear turns exactly one full revolution as the opening curtain crosses the aperture. Consequently, its stud returns to the original position. When you then let up the release plunger, everything returns to normal — the flat release spring pushes up the release plunger and the interlocking studs once again engage.

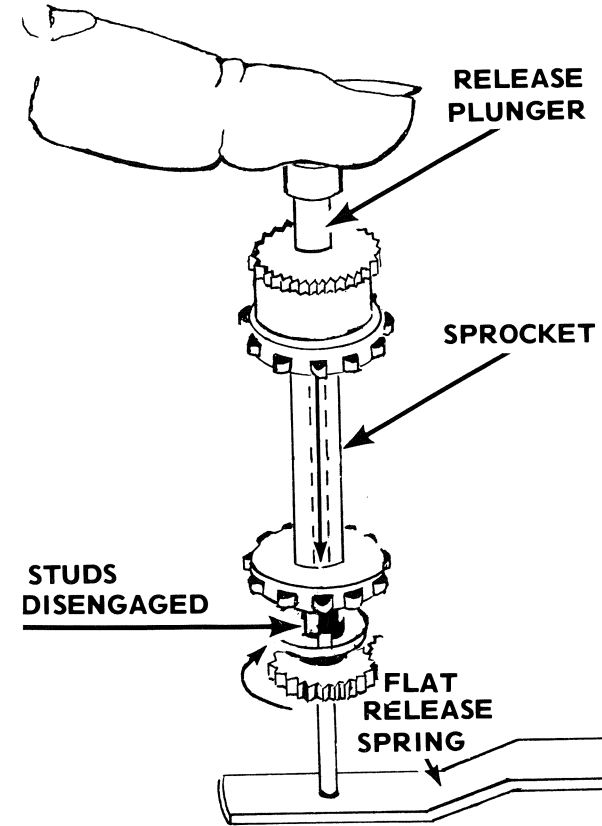

FIGURE 30 FIRST CURTAIN WIND GEAR IS FREE TO ROTATE (IN DIRECTION OF ARROW)

THE LEICA - TYPE SHUTTER

The release plunger passes through the center of the sprocket and through the center of the first-curtain-wind gear, Fig. 29. An E-ring holds the first-curtain-wind gear to the bottom of the release plunger. So the first-curtain-wind gear is free to turn around the axis provided by the release plunger. Depressing or raising the release plunger controls the vertical position of the first-curtain-wind gear.

A flat release spring on the bottom of the camera pushes up the release plunger, Fig. 30. In turn, the release plunger holds up the first-curtain-wind gear — that keeps the interlocking studs engaged.

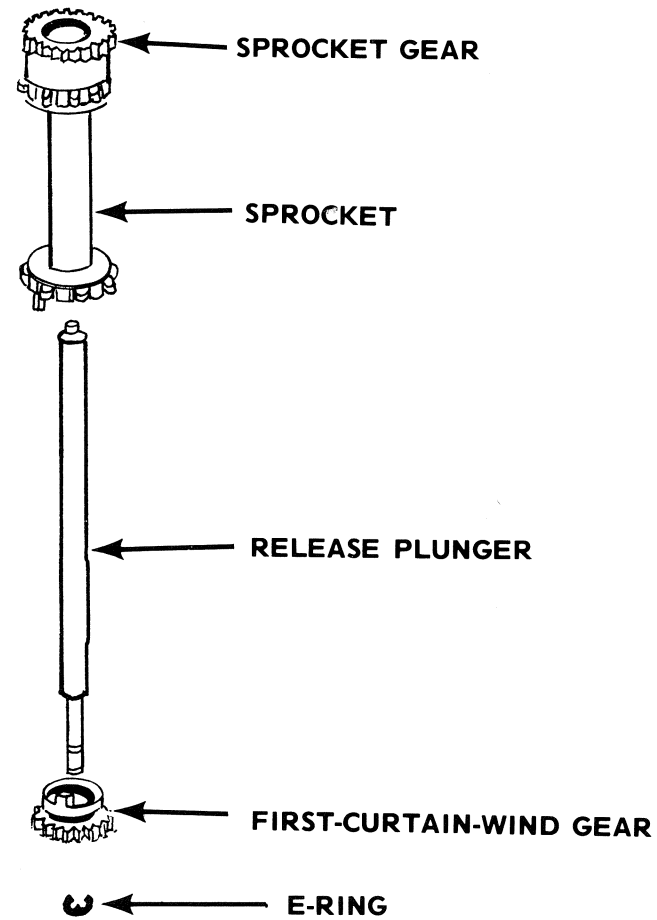

FIGURE 29 SPROCKET AND RELEASE PLUNGER

Now, the curtains are in the "ready" position, Fig. 26. At this time, the drum gear can't turn in a clockwise direction — that holds the opening curtain against the tension of the take-up roller. And, since the opening-curtain drum can't turn, the closing-curtain drum is held — its pin is still against the end of the slot in the upper end of the opening-curtain drum. The spring-loaded take-up rollers are trying to pull the drums clockwise (as indicated by the curved arrows in Fig. 26). But they can't do so until we free the drum gear.

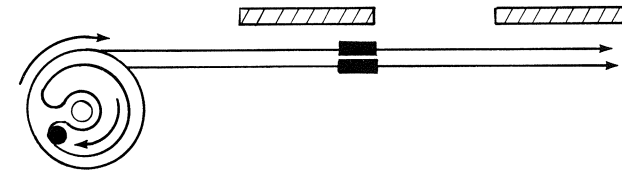

FIGURE 26 COCKED POSITION — ARROWS INDICATE DIRECTION OF PULL OF TAKE-UP-ROLLER SPRINGS

Depressing the shutter release allows the drum gear to rotate in a clockwise direction. Now, the opening-curtain take-up roller pulls its curtain across the focal-plane aperture, Fig. 27. Notice in Fig. 27 that the opening-curtain drum no longer holds the closing-curtain drum — the closing-curtain drum is free to turn in the direction of the curved arrow.

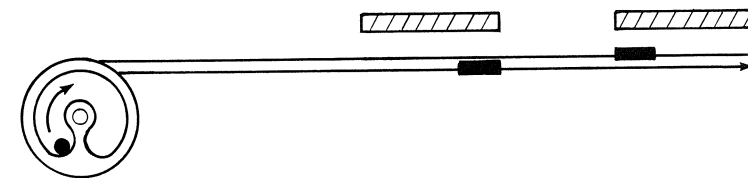

FIGURE 27 OPENING-CURTAIN DRUM RETURNED — CLOSING-CURTAIN DRUM IS FREE TO ROTATE IN DIRECTION OF ARROW

With no other controls, the closing curtain could follow the opening curtain. The result — no slit. But, as you know, there are other controls to restrain the closing-curtain drum and release it later. You'll soon see the timing controls that hold back the closing curtain.

THE LEICA-TYPE SHUTTER

The Curtain-Winding Mechanism

Remember, both curtains wind simultaneously through the pin coupling of their respective drums. And the curtains move independently in the release direction — each is pulled by its own take-up roller. Now, we can add the parts to turn the drum gear and wind the curtains, Fig. 28.

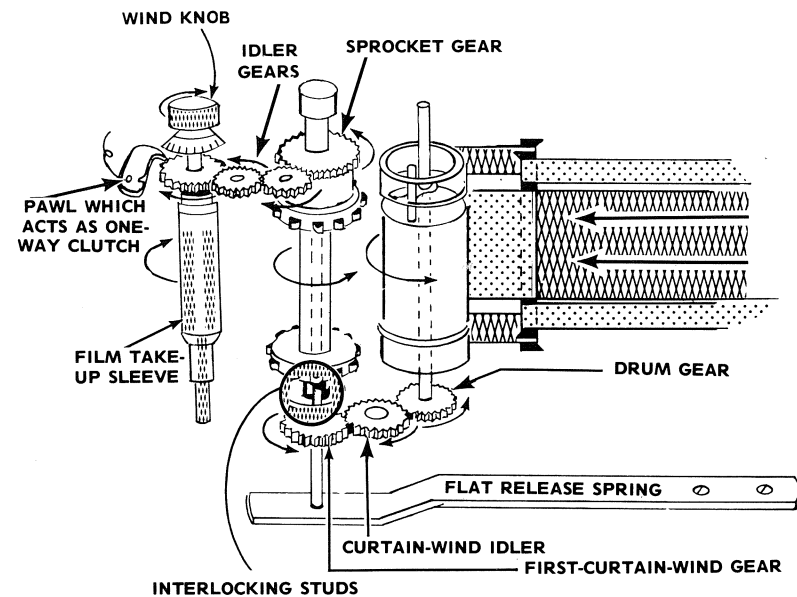

FIGURE 28 ARROWS INDICATE TRAVEL DIRECTIONS DURING WIND CYCLE

Turning the **wind knob** advances the film and cocks the shutter. Two separate gear trains transfer the wind-knob rotation to the drum gear. The upper gear train transports the film — it consists of **a gear on the film take-up sleeve, two idler gears, and a gear on the top of the sprocket**. The film take-up sleeve has a one-way clutch which prevents the curtains from pulling the gear train in the opposite direction.

As the upper gear train turns the sprocket gear, the sprocket turns in the direction of the curved arrow, Fig. 28. The sprocket, you'll recall, is the part that meters the film. Simultaneously, the film take-up spool rotates in the same direction to wind on the film — the film take-up spool isn't shown in the drawing, but it fits over the film take-up sleeve and is held by friction.

The lower gear train winds the curtains. By the time the stop pin arrests the opening-curtain drum in the "ready" position, the sprocket has metered off one complete film frame. And you won't be able to turn the wind knob any further.

One point of interest here is that the Leica was the first camera to combine film transport with the shutter wind. Since the curtains wind in the same direction as the film advances, it's convenient to couple the two mechanisms.

So everything comes to a halt when the shutter reaches the fully cocked position. The curtains can't pull against the one-way clutch, Fig. 28. Consequently, the two gear trains must disengage before the shutter can release.

The upper gear train must not turn opposite the direction of the film advance. Yet the lower gear train must rotate in both directions — the complete gear train always follows the rotation of the drum gear. In typical focal-plane fashion, the shutter needs a **transport-release mechanism**.

The transport-release mechanism consists of the two interlocking studs at the bottom of the sprocket, Fig. 28. One stud mounts to the sprocket — the other attaches to the top of the first-curtain-wind gear.

As the sprocket turns to advance the film, its downward-projecting stud comes against the stud on the first-curtain-wind gear. So through the interlocking studs, the sprocket turns the lower gear train. And the lower gear train winds the curtain.

The first-curtain-wind gear then holds the curtains in the "ready" position — it can't turn because its stud is still against the stud at the bottom of the sprocket. And the sprocket can't turn against the one-way clutch. To release the shutter, we must disengage the interlocking studs — that's the job of the **release plunger**.